

1. ELEVATE BLEACHER TO RECEIVE WHEEL UNITS.
2. INSERT WHEEL AND AXLE ASSEMBLY INTO AXLE SLEEVE AS SHOWN.
3. INSERT 7/16" X 3" GALVANIZED MACHINE BOLT THROUGH AXLE TO SECURE IN AXLE SLEEVE.

WHEEL AND AXLE ATTACHMENT

1" = 1'-0"

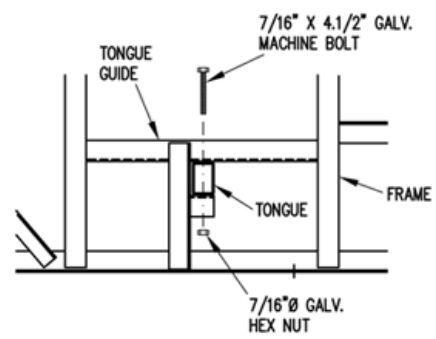

1. INSERT TONGUE THROUGH TONGUE GUIDES.
2. ATTACH TONGUE TO TONGUE BRACKETS WITH 7/16" X 4.1/2" GALVANIZED MACHINE BOLTS AS SHOWN.
3. TIGHTEN SECURELY.

TONGUE ATTACHMENT

1" = 1'-0"

TRANSPORT KIT FOR 5 & 10 ROW X 27' L BLEACHERS